

Project	
Type	
Contact	

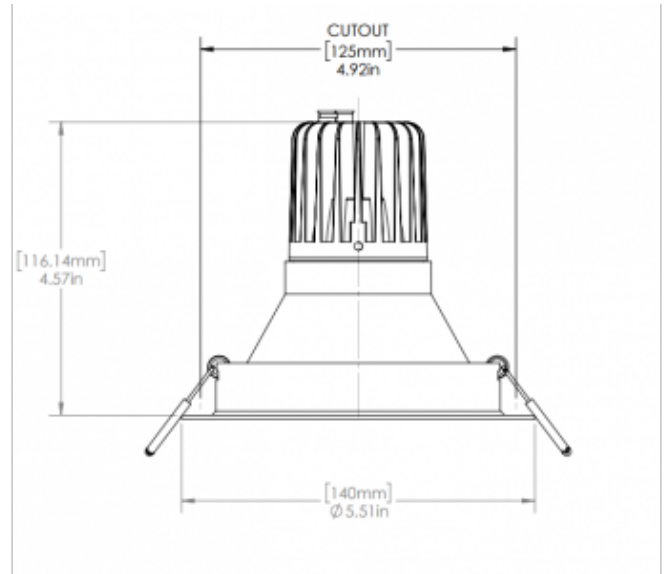

**Luna 4 A**  
**1 Light Sources**  
**4 in. | 1106 lm / per light source**  
**Round | Fixed | Downlight**

Performance Options	9W	13W		
Source Lumens	1188 lm	1563 lm		
Delivered Lumens	840 lm	1106 lm		
Lumens / Watt	93 lm	85 lm		
Current	250 mA	350 mA		
CRI/CCT Multiplier	2700°K	3000°K	3500°K	4000°K
80 CRI	0.93	1.00	1.00	1.07
95 CRI	0.69	0.75	0.81	0.87

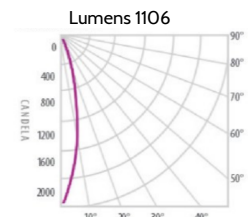
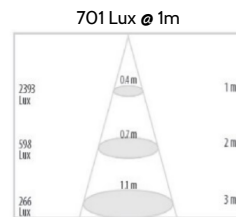

D2	LUN4A	13	30	A	3	C	WS	O	O	D
Options	Model	Wattage	Kelvin	CRI	Beam	Lens	Color	Driver	Installation	I.P. Rating
D2	LUN4A:Luna 4 A	09:09W 13:13W	27:2700° 30:3000° 35:3500° 40:4000° AM:Amber WD:Warm Dim	A:80 B:95	1:10° 2:24° 3:36° 6:60°	C:Clear F:Frosted H:Hex Louver + Clear X:Hex Louver + Solite P:Prismatic S:Solite	WS:Matte White BK:Matte Black WK:White / Black Inter Splay CC:Custom-Min Qty:2Opc	O:No Driver Z:0-10V Dimmable to 1% E:ELV Dimmable T:Lutron™ L:Lutron™ N:Non-Dimmable A:0-10V Dimmable to 1% +EM Backup F:ELV Dimmable +EM Backup M:Lutron™ U:Lutron™ Q:Non-Dimmable +EM Backup D:DALI	O:No Accessories D:Class 2, Non-IC E:Airtight Enclosure F:Chicago Plenum G:Title 24 for Residential R:Retro-Fit Enclosure RL:Retro-Fit for Lutron™ A:Class 1, IC B:Class 1, Non-IC	D: Dry IP 20 W:Wet IP 65

Generated on 11-30-2018

## Specifications

This specification Grade LED downlight offers a wide selection of LED modules options to address design requirements in the spaces it illuminates. Many additional custom options are available; please contact manufacturer for details.

### LED source

Tool-free field-replaced LED module. Proprietary high performance aluminum die cast heatsink for maximum LED life.

### Optics

Computer-optimized reflector design. High reflected finish aluminum. Tool-free field-interchangeable reflectors and lens. 0-20°(O version), 0-40°(J version) vertical and 360° horizontal adjustment.

### Body

Die-cast aluminum frame and body.

### Trim

Die-cast aluminum CNC machine finished Minimal thickness. White can be field painted to match adjacent finishes

### Fixture retention

Two torsion springs hold the fixture tight to the ceiling accommodating ceiling thickness fromm 1/16" to 1". Special springs for thicker ceiling available on request.

### Life

Rated for 50,000 hours at 70% lumen maintenance.

### Label

Etl listed for US Canada. CE labeled. CCC label available on request.

### Warranty

5 years limited warranty.

### Wet location

(if option is available ont and selected on page 1)

Sealed lens and integral silicon gasket behind the trim.

## Dimming compatibility

Zaniboni fixture are compatible with all major dimming protocol in the industry. Please refer to [zanibonilighting.com](http://zanibonilighting.com) for general compatibility and wiring diagrams. Zaniboni recommends testing your unique dimming configuration as the exact full configuration (Dimmer, drivers, fixture quantities, voltage) may affect dimming performance.



### N: Non-Dimmable

110-277V, 50/60Hz.

Economic solution for ON-OFF applications not requiring dimming.



### E: ELV Dimmable

110-277V, 50/60Hz.

For ELV(Electronic Low Voltage) dimmers. Best for new construction application. Dims down to less than 10% light output(most cases). Consult dimming manufacturer for installation instructions. Must meet dimmer Minimum load Requirements.

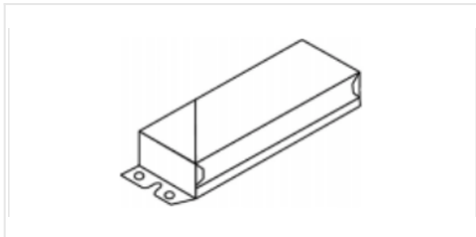

### Z: 0-10V Dimmable

110-277, 50/60Hz.

Prevalent solution on commercial projects. Integrates into a variety of building management and day lighting controls. Dims down to less than 10% light output(most cases). Must meet dimmer Minimum Load Requirements. Consult dimming manufacturer for installation instructions.

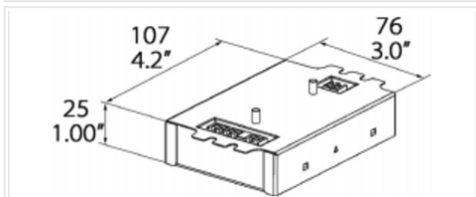

### L: Lutron Hi-Lume A L3D

120-277V, 50/60Hz.

For 3-wire LUTRON dimming systems. Continuous dimming to 1% Consult dimming manufacturer for installation instructions.

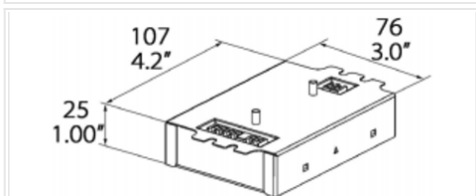

### T: Lutron Hi-Lume A LTE

120V, 50/60Hz.

For 2-wire Forward Phase Controls. Continuous dimming to 1% Consult dimming manufacturer for installation instructions.

### N&E: Non-Dimmable & ELV Drivers

Measurements	LWH in mm	LWH in inches
7W - 9W - 13W	85.5 - 38 - 27.7	3.36" - 1.49" - 1.09"
18W - 26W	89 - 41 - 31.5	3.5" - 1.62" - 1.24"
36W - 50W	89 - 41 - 31.5	3.5" - 1.62" - 1.24"

### N&E: Non-Dimmable & ELV Drivers

Measurements	LWH in mm	LWH in inches
7W - 9W - 13W	85.3 - 38 - 27.7	3.36" - 1.49" - 1.09"
18W - 26W	89 - 41 - 31.5	3.5" - 1.62" - 1.24"
36W - 50W	138 - 47 - 32	5.43" - 1.85" - 1.25"

## Enclosures

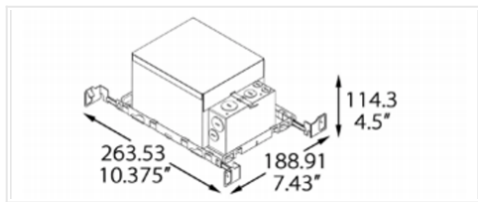

### A: Class 1, IC

For installation in ceilings with insulation. Driver "on board".

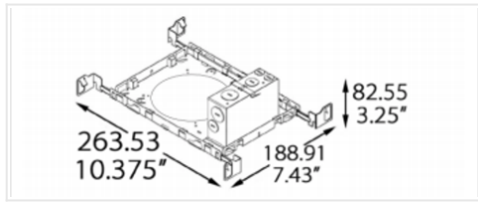

### B: Class 1, Non-IC

For installation in ceilings with insulation. Driver "on board".

National or municipal codes must be followed regarding set back of thermal insulating material from fixture. Fixture are not designed for direct contact with thermal insulation.

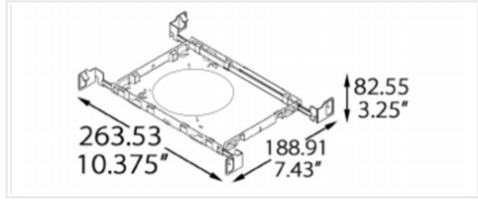

### D: Class 2, Non-IC

For installation on ceiling without insulation

National or municipal codes must be followed regarding set back of thermal insulating material from fixture. Fixture are not designed for direct contact with thermal insulation.

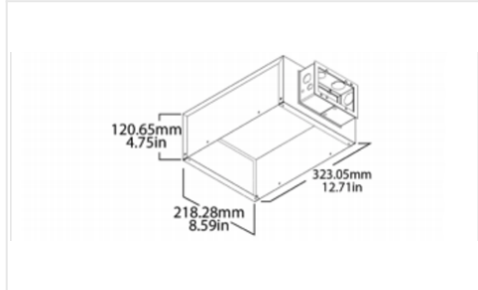

### E: Airtight Enclosure

For installation where AT(Air-Tight) standards is required.

### F: Chicago Plenum

Enclosure complies with Chicago Plenum requirements

### G: Title 24 for Residential

Enclosure complies with California Title 24 requirements for specific residential applications. Please consult with your local inspector

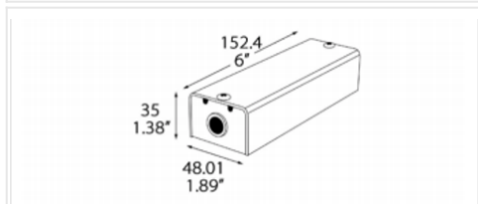

### R: Retro Fit-Enclosure

Available in assorted cutout sizes for easy installation of light fixture. For installation in plaster or t-bar ceilings.

National or municipal codes must be followed regarding set back of thermal insulating material from fixture. Fixture are not designed for direct contact with thermal insulation.

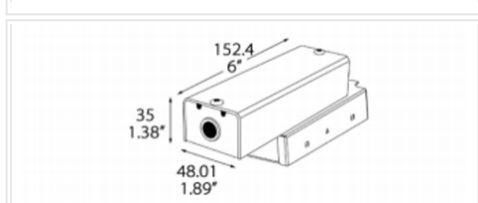

### R: Retro Fit-Enclosure Coupled Wit Lutron HI-Lume Driver

When the Retro-Fit Enclosures is paired with any Lutron Driver, the Lutron Driver will be mounted atop the Retro-Fit enclosure with the line voltage connection inside the junction box.

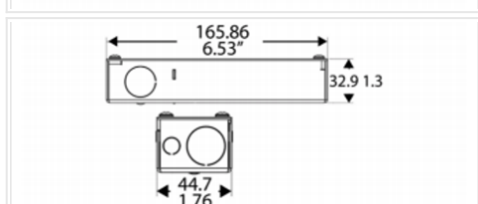

### R: Retro-Fit Mini

Used with our 1" aperture Lunas&Albas.

National or municipal codes must be followed regarding set back of thermal insulating material from fixture. Fixture are not designed for direct contact with thermal insulation.