

Features

- 24VDC Class 2 fixtures made to order up to 144". Fixtures can be linked up to 35' depending on output
- Suitable for undercabinet, millwork recessed and surface mount applications
- Approved for closet/storage space installation per NEC 410.16(A)(3) and 410.16(C)(5)
- Dot free even illumination achievable with frosted lens
- Louvers and Glare Shields available for clear, half-frosted, frosted & graze lens
- Vibrant colors with R9 values up to 98
- Single micro binned LEDs +/- 30 CCT
- Dims with minimal color shift
- Class 2 listed for damp locations
- Proprietary strong bond solder method handles up to 50lbs of torque on wire leads and connectors
- 5 Year warranty



Finish options



- Silver anodized
- Black powder coated
- Bronze powder coated
- White powder coated

Profile dimensions

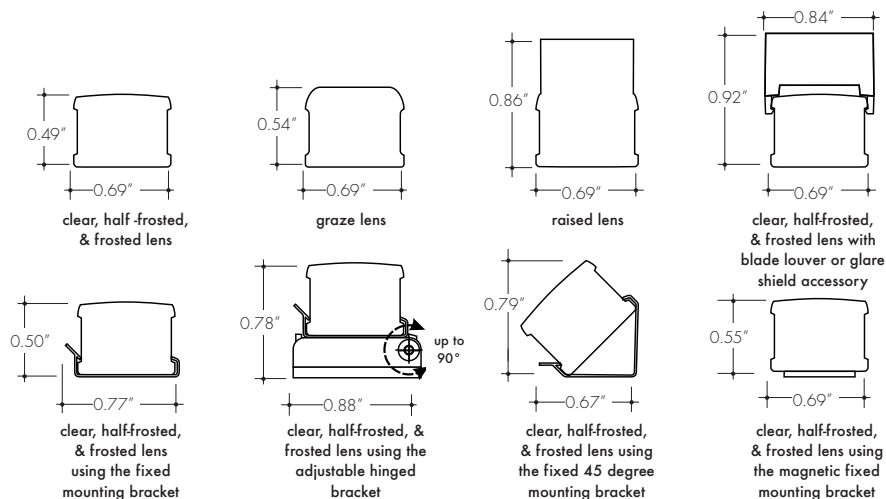

Technical information

OUTPUT OPTIONS

Output	Lumens at 3000K (with clear lens)	Average power consumption at 4'	Lumens / Watt (with clear lens)	Maximum system length In series
SO (LL36)	199 lm/ft	3.2 W/ft	64 lm/W	35'
HO (LL54)	295 lm/ft	5.2 W/ft	62 lm/W	26'
VHO (LL72)	408 lm/ft	6.5 W/ft	65 lm/W	18'

CCT INFO/LUMEN MULTIPLIER

Color temperature	Multiplier (reference - 3000K)	CRI	R _f	R _g
2200K	0.87	86	87	98
2400K	0.73	98	95	102
2700K	0.81	97	95	101
2900K	0.86	97	94	101
3000K	1.00	91	89	98
3500K	1.05	94	90	102
4100K	1.28	94	86	96

TM-30-15

Ordering code

MODEL	LENGTH	CCT	OUTPUT	LENS	MOUNTING	FINISH	POWER FEED POSITION / TYPE	ACCESSORIES
KM	12	22K	SO	C	FC	SA	E	1
<small> KM - Kendo M LENGTH - 12" - 144" 4" increments CCT - 22K - 2200 K, 24K - 2400 K, 27K - 2700 K, 29K - 2900 K, 30K - 3000 K, 35K - 3500 K, 41K - 4100 K OUTPUT - SO - Standard, HO - High, VHO - Very High LENS - C - Clear, HF - Half-Frosted, F - Frosted, G - Graze, *R - Raised MOUNTING - FC - Fixed clip, AH - Adjustable hinge mounting, FC45 - Fixed clip 45 degree, MAG - Magnetic FINISH - SA - Silver, BK - Black, BZ - Bronze, WH - White (BK,BZ,WH finishes will have an upcharge and require longer lead times) POWER FEED POSITION / TYPE - E - End, B - Bottom, S - Side, 1X2 - 72" wire leads at both ends and quick connect at other, 2 - 72" wire leads at one end and quick connect at other, 3 - Single quick connect, 4 - Dual quick connect ACCESSORIES - BLS - N/A, leave blank, BLS - Blade louver, Silver, BLBK - Blade louver, Black, BLWH - Blade louver, White, GSS - Glare shield, Silver, GSBK - Glare shield, Black, GSWH - Glare shield, White </small>								

*Will not work with louver & shield Accessory

Photometry

KM-48-30K-VHO-CXX

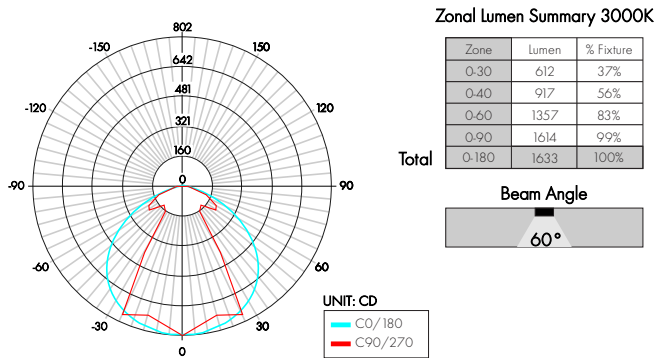

KM-48-30K-VHO-HF-XX

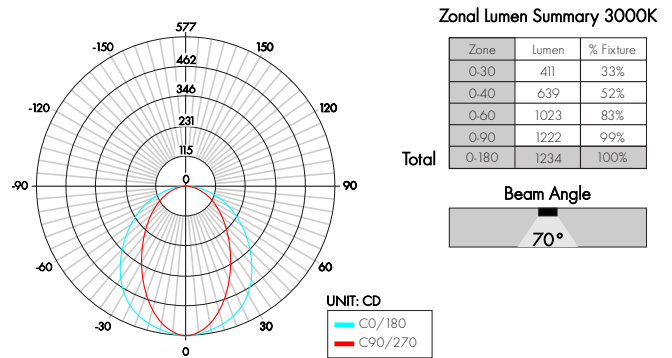

KM-48-30K-VHO-F-XX

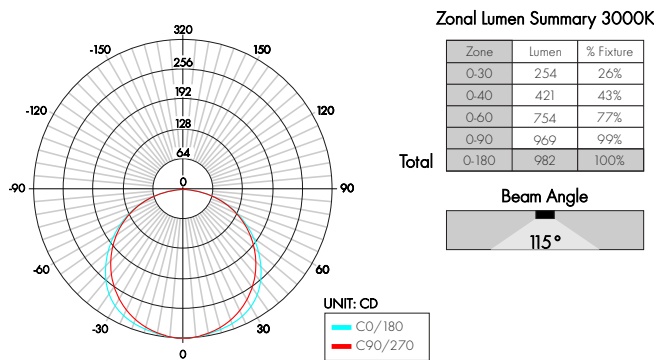

KM-48-30K-VHO-G-XX

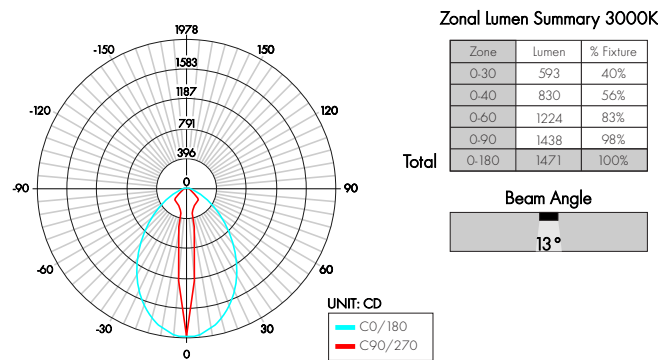

KM-48-30K-VHO-R-XX

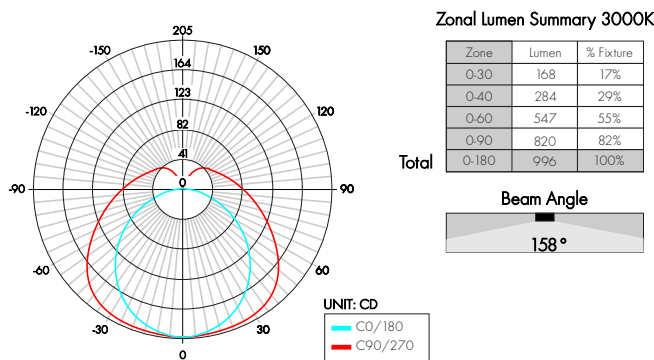

Fixture with Accessory

KM-48-30K-VHO-G-BLWH-XX

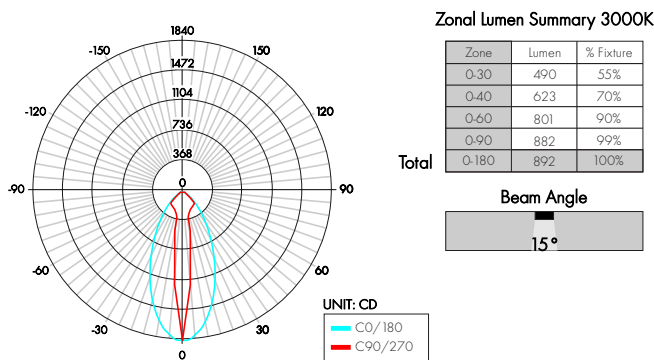

KM-48-30K-VHO-G-GSWH-XX

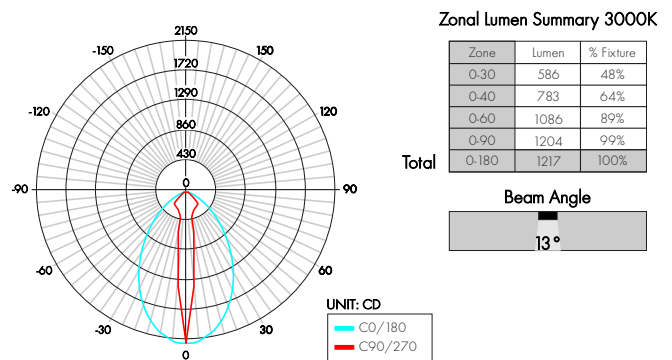

Light Transmission

Lens/Accessory	Percentage Light Transmission
clear lens	100%
graze lens	90%
half-frosted lens	76%
graze lens w/ white blade louver	75%
raised lens	61%
frosted lens	60%
graze lens w/ white glare shield	55%

LED Dotting per extrusion

output	Lens				
	Clear	Half - Frosted	Frosted	Raised	Graze
SO (LL36)	CD	CD	ND	ND	CD
HO (LL54)	CD	CD	ND	ND	CD
VHO (LL72)	CD	CD	ND	ND	CD

CD = Clear Dotting
SD = Slight Dotting
ND = No Dotting

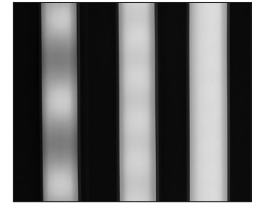

Clear Dotting Slight Dotting NO Dotting

Power consumption per fixture length

Based on operation with PSD series of power supplies.

Nominal Length	Actual Length	SO		HO		VHO			
		W/ft	Total wattage	Actual Length	W/ft	Total wattage	Actual Length	W/ft	Total wattage
12"	12-12/16"	3.25	3.25	12-11/16"	5.35	5.30	12-11/16"	6.75	6.75
16"	16-10/16"	3.25	4.00	16-10/16"	5.33	7.06	16-9/16"	6.75	9.00
20"	20-10/16"	3.25	5.25	20-10/16"	5.31	8.82	20-9/16"	6.75	11.25
24"	24-8/16"	3.25	6.50	24-9/16"	5.30	10.60	24-8/16"	6.75	13.50
28"	28-7/16"	3.25	7.75	28-7/16"	5.28	12.33	28-7/16"	6.75	16.75
32"	32-7/16"	3.25	8.50	32-7/16"	5.26	14.06	32-6/16"	6.75	19.00
36"	36-5/16"	3.25	9.75	36-6/16"	5.25	15.80	36-5/16"	6.65	19.95
40"	40-4/16"	3.25	10.25	40-5/16"	5.23	17.40	41-4/16"	6.65	22.20
44"	44-4/16"	3.20	11.75	44-4/16"	5.21	19.00	45-3/16"	6.65	24.40
48"	48-3/16"	3.20	12.80	48-3/16"	5.20	20.60	49-2/16"	6.55	26.20
52"	52-2/16"	3.20	13.30	53-7/16"	5.18	22.40	53-1/16"	6.55	28.50
56"	56-1/16"	3.20	14.80	57-6/16"	5.16	24.20	57 "	6.55	30.50
60"	60 "	3.20	16.00	61-5/16"	5.15	26.00	60-15/16"	6.45	32.25
64"	63-15/16"	3.20	17.00	65-4/16"	5.13	27.60	64-14/16"	6.45	34.40
68"	69-13/16"	3.15	18.00	69-3/16"	5.11	29.20	68-13/16"	6.45	36.55
72"	73-12/16"	3.15	18.90	73-2/16"	5.10	30.80	72-12/16"	6.40	38.40
76"	77-11/16"	3.15	19.00	77-1/16"	5.08	32.40	76-11/16"	6.40	40.50
80"	81-11/16"	3.15	21.50	81-1/16"	5.06	34.00	80-10/16"	6.40	43.00
84"	85-9/16"	3.15	22.05	85 "	5.05	35.70	84-9/16"	6.25	43.75
88"	89-8/16"	3.15	23.00	88-14/16"	5.03	37.10	88-8/16"	6.25	46.00
92"	93-7/16"	3.10	24.00	92-13/16"	5.01	38.50	92-7/16"	6.25	48.00
96"	97-6/16"	3.10	24.80	96-13/16"	5.00	40.00	97-6/16"	6.15	49.20
100"	101-6/16"	3.10	26.30	100-12/16"	4.98	41.60	101-5/16"	6.15	51.25
104"	105-4/16"	3.05	27.10	104-11/16"	4.96	43.20	105-3/16"	6.15	53.00
108"	109-4/16"	3.05	28.00	108-10/16"	4.95	44.80	109-3/16"	6.00	54.00
112"	113-3/16"	3.05	28.50	112-9/16"	4.93	46.20	113-2/16"	6.00	56.00
116"	117-1/16"	3.05	30.00	116-8/16"	4.91	47.60	117-1/16"	6.00	58.00
120"	121-1/16"	3.00	30.50	120-8/16"	4.90	48.90	121 "	5.90	59.00
124"	125 "	3.00	31.50	124-7/16"	4.88	50.40	124-15/16"	5.90	60.60
128"	128-14/16"	3.00	32.50	128-6/16"	4.86	51.90	128-14/16"	5.90	62.20
132"	132-14/16"	2.95	33.50	132-5/16"	4.85	53.30	132-13/16"	5.80	63.80
136"	136-13/16"	2.95	34.30	136-4/16"	4.83	54.70	136-12/16"	5.80	65.30
140"	140-12/16"	2.95	35.20	140-3/16"	4.81	56.10	140-11/16"	5.80	66.80
144"	144-11/16"	2.90	36.00	145-7/16"	4.80	57.40	144-10/16"	5.70	68.40

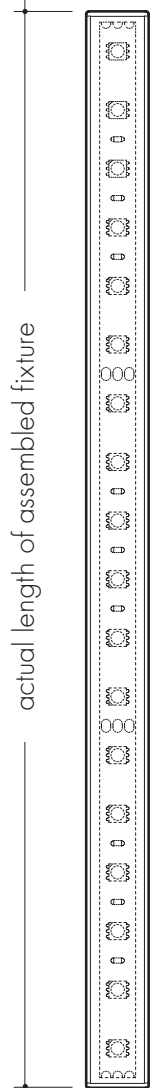

Connectors & Accessories

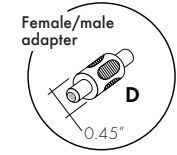
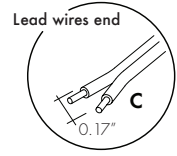
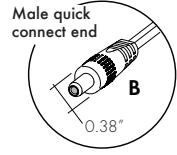
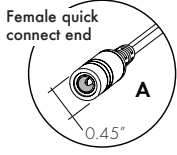

Linking and extension cable options

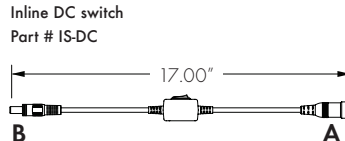
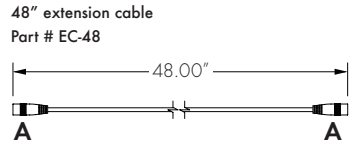
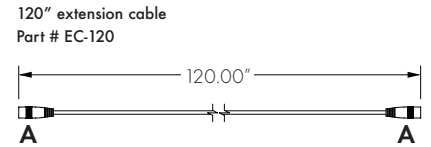
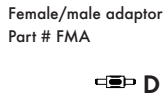
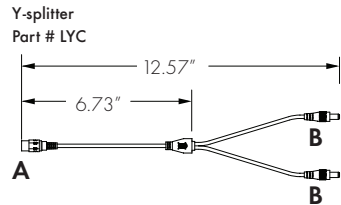
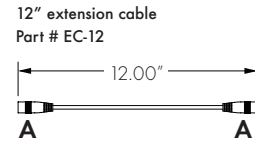
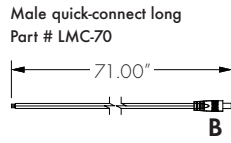
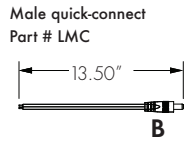

Powerfeed Position / Type

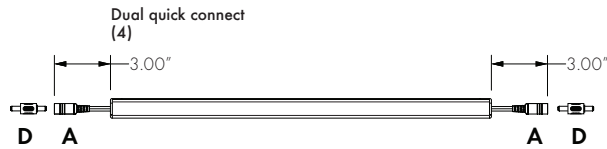
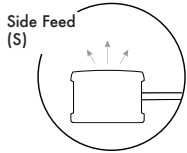
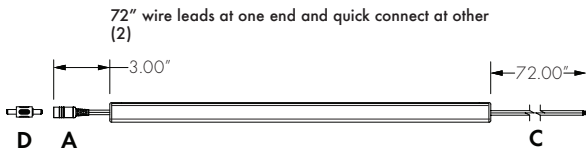
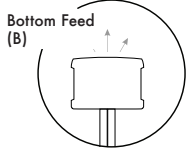
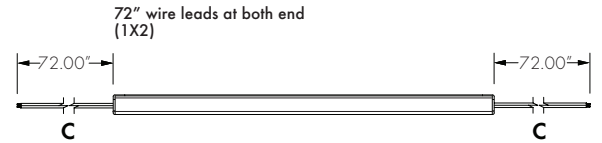
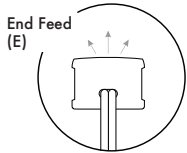

3, and 4 powerfeed options require #LMC to connect to PSD series of power supplies.

Accessory options

Glare Shield:
redirect the light to avoid glare from fixture
*available only with complete fixture
reference page 1 ordering code*

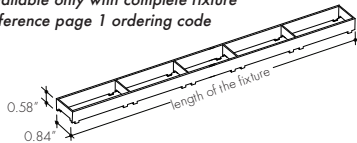

Blade Louver:
control light distribution
*available only with complete fixture
reference page 1 ordering code*

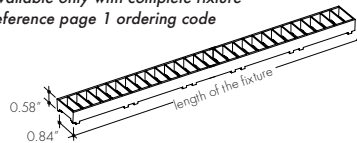

Splice Box:
Low voltage, 4 terminal splice box, black

Part # LVSP-4T-BK

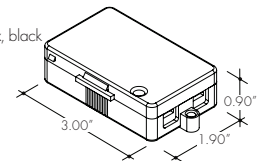

Sample layout

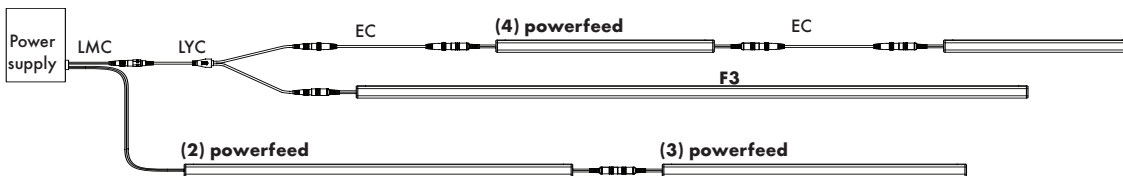

Power supply

See fixture and power supply instructions & spec sheet for wiring information. Dimming possible in select models - view Luminii website for list of compatible dimmers.

Magnetic Low Voltage Dimming Power Supplies:

MODEL	POWER	OUTPUT	INPUT
PSD	48	24	
PSD - PSD Series dims down to 0%	48 - 48 W 96 - 96 W 288 - 288 W (3x 96W)	24 - 24 VDC	Blank - 120 V 240 - 240 V 277 - 277 V

MODELS	PSD 48	PSD 96	PSD 288
A Length	11.25"	11.25"	13.06"
B Width	3.42"	3.42"	8.42"
C Depth	3.42"	3.27"	4.47"

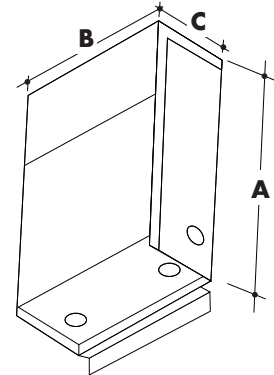

Electronic Low Voltage Dimming Power Supplies:

MODEL	CIRCUIT x POWER	OUTPUT	INPUT
CVE	48D	24	
CVE - CVE Series dims down to 0.1%	48D - 48W 48X2D - 2 x 48W 48X3D - 3 x 48W 48X4D - 4 x 48W 96D - 96W 96X2D - 2 x 96W 96X3D - 3 x 96W 96X4D - 4 x 96W	24 - 24 VDC	Blank - 120 V 277 - 240/277 V

MODELS	Single circuit	Dual circuit	Three circuit	Four circuit
A Length	13.9"	13.8"	13.8"	13.8"
B Width	2.3"	4.0"	5.9"	7.75"
C Depth	1.3"	1.9"	1.9"	1.9"

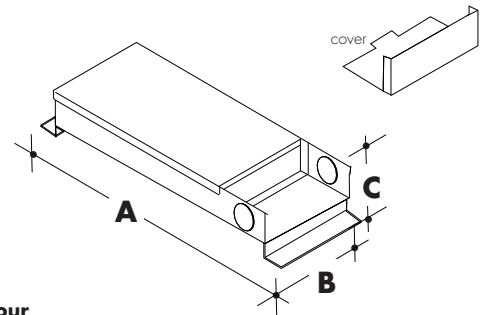

0-10V Dimming Power Supplies:

MODEL	POWER	OUTPUT	DIMMING
PSO10V	3X96	24	LIN
PSO10V - 0-10V Power Supply dims down to 0%	96 - 96 WATT 3X96 - 3 X 96 WATT	24 - 24 VDC	LIN - Linear LOG - Logarithmic

MODELS	96 W	3X96
A Length	14.40"	15.75"
B Width	5.20"	6.60"
C Depth	2.60"	4.80"

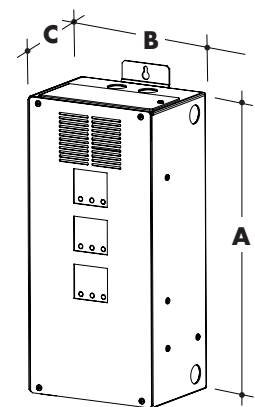

MODEL	POWER	OUTPUT	DIMMING	LOCATION
PSV	40	24	U2DIM	D
PSV - PSV Series dims down to 5%	40 - 40 W 60 - 60 W 96 - 96 W	24 - 24 VDC	U2DIM - Dimming 0-10V	D - Dry Location IP65 - Wet Location

MODELS	PSV Dry	PSV Wet
A Length	9.2"	9.5"
B Width	3.4"	4.12"
C Depth	1.9"	2.3"

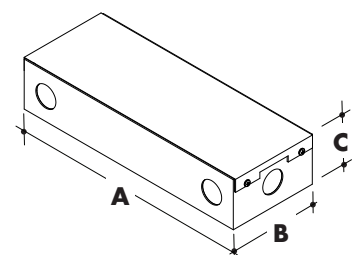

Power supply

See fixture and power supply instructions & spec sheet for wiring information. Dimming possible in select models - view Luminii website for list of compatible dimmers.

DMX Dimming Power Supplies:

MODEL	POWER	OUTPUT
PSDMX	96	24
PSDMX - DMX Power Supply	96 - 96 WATT 3X96 - 3 X 96 WATT	24 - 24 VDC

- Features eldoLED's LINEARdrive configurable dimmable drivers

MODELS	3X96 W
A Length	15.75"
B Width	6.60"
C Depth	4.80"

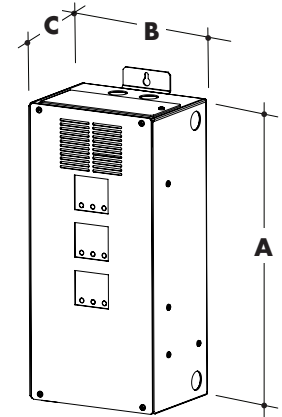

DALI Dimming Power Supplies:

MODEL	POWER	OUTPUT
PSDALI	96	24
PSDALI - DALI Power Supply dims down to 0%	96 - 96 WATT 3X96 - 3 X 96 WATT	24 - 24 VDC

- Features eldoLED's LINEARdrive configurable dimmable drivers

MODELS	96 W
A Length	14.40"
B Width	5.20"
C Depth	2.60"

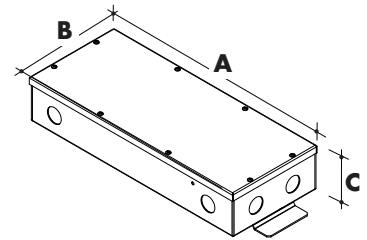

Luminii is a Lutron OEM Advantage Partner

MODEL		
LTEA4U1UKL-CV240		
Lutron - Hi-lume™ 1% 2-wire LED driver (120V forward phase only)		

MODELS	LTEA	L3DA
A Length	4.89"	4.89"
B Width	2.66"	2.66"
C Depth	4.00"	4.00"

MODEL		
L3DA4U1UKL-CV240		
Hi-lume™ 1% EcoSystem Voltage LED Driver		

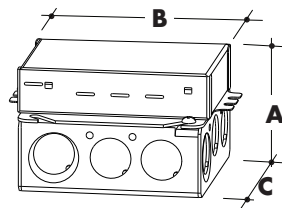

MODEL		
L3DO-96W24V-U		
Hi-lume™ 0.1% EcoSystem Voltage LED Driver with Soft-On, Fade-to-Black™		

MODELS	L3DO
A Length	10.50"
B Width	5.50"
C Depth	2.00"

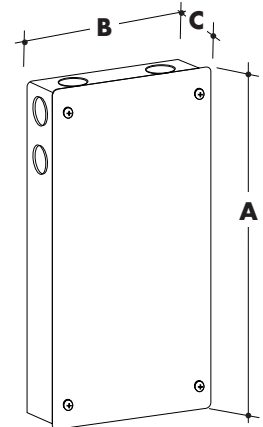

Power supply

See fixture and power supply instructions & spec sheet for wiring information. Dimming possible in select models - view Luminii website for list of compatible dimmers.

Enlighted Enabled Dimming Power Supplies:

MODEL	POWER	OUTPUT	DIMMING	Location
PSV	96	24	ENL	D
PSV - LED Power Supply	96 - 96 WATT	24 - 24 VDC	ENL - Enlighted Dimming	D - Damp

MODELS	96 W
A Length	14.40"
B Width	5.20"
C Depth	2.60"

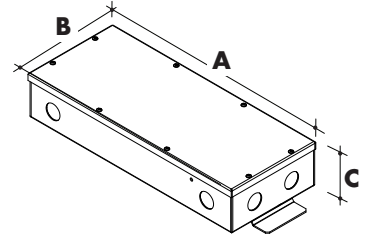

Non-Dimming Power Supplies:

MODEL	POWER	OUTPUT	DIMMING	LOCATION
PSV	40	24	U2ND	D
PSV - PSV Series	40 - 40 W 60 - 60 W 96 - 96 W	24 - 24 VDC	U2ND - Non Dimming	D - Dry Location IP65 - Wet Location

MODELS	PSV Dry	PSV Wet
A Length	9.2"	9.5"
B Width	3.4"	4.12"
C Depth	1.9"	2.3"

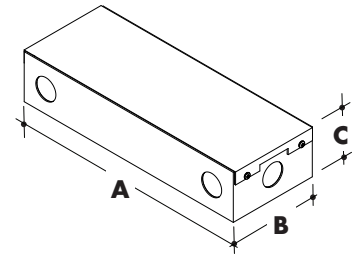

In ground, Electronic Low Voltage Dimming Power Supplies:

MODEL	CIRCUIT x POWER	OUTPUT	INPUT
IG-CVE	96X2	24	
IG-CVE - In ground CVE Series dims down to 0.1%	96X2 - 2 x 96W	24 - 24 VDC	Blank - 120 V 277 - 240/277 V

MODELS	Dual circuit
A Length	8.0"
B Width	8.0"
C Depth	8.0"

