

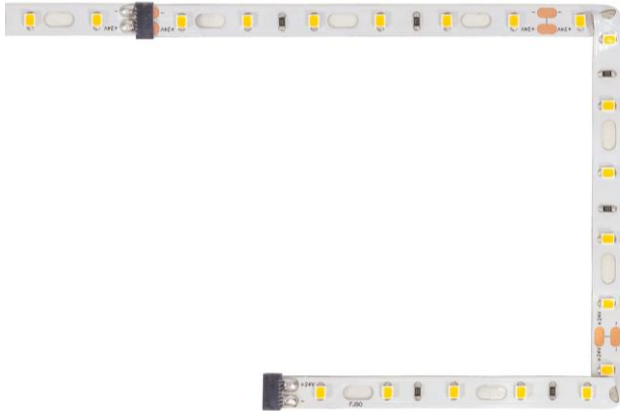

DL-FLEX2-UP-3D

3D BENDABLE LED FLEXIBLE LINEAR
24VDC LED FLEXIBLE TAPE

Type	
Project	
Catalog No.	



DESCRIPTION

JESCO Lighting's DL-FLEX2-UP-3D is a flexible LED tape that is bendable in both the horizontal and vertical planes. The tape is ideal for intricate shapes and turns – as found in backlighting applications such as signage lettering. Bendable every 2 LEDs (1.31") at the designated gaps.

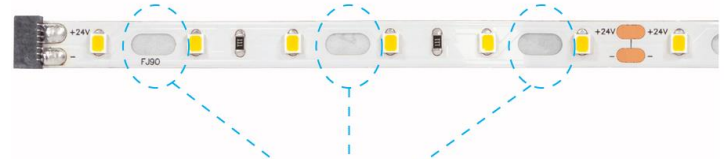

Bending gaps after every 2 LEDs (1.31")

FLEX2-UP quick connectors every 12" eliminates the need for field soldering. The tape is field-cuttable for shorter runs. Easy installation to most surfaces categorized as having high surface energy using pre-attached 3M® double sided tape. The tape is dimmable using JESCO's various dimming options.

SPECIFICATIONS

Input Voltage	24V DC
Lamp Life	50,000 hours
CRI	90+
LED Density	18 LEDs/ft
Ambient Temperature *	-4 to 122°F (-20 to 50°C)
Dimensions	11-7/8"L x 3/8"W x 1/8"H
Max Run†	17 ft
Cut length	3-15/16"
Beam Angle	120°
Environment	Indoor – Dry
Certifications	US LISTED
Warranty	5 Years – see published warranty terms for detailed information.

* Exceeding the ambient or operating temperature values may damage the LEDs by reducing the lifespan, lumen output, and/or adversely impact color consistency. It is recommended adequate airflow and heatsinking be taken into consideration in the installation and application of this product. Improper thermal management may lead to premature product failure and void the warranty.

† Single runs can not exceed max run length. Cuts can only be made on the cutting mark.

LUMEN DATA

Color Temp	Watts * (per ft)	Lumens (per ft)	Efficacy (lm/W)
2700K	2.20	166	75
3000K	2.20	169	77
4000K	2.20	174	79

FEATURES

- Bendable in both the horizontal and vertical planes
- Bending gaps every 2 LEDs (1.31")
- FLEX2-UP quick connectors every 12" eliminates the need for field soldering
- 3-Step MacAdam LED binning for uniformity in both color and intensity
- 2 oz. copper PCB ensures optimal heat dissipation
- Easy installation with 3M™ adhesive tape and a large variety of channel options available
- Field-cuttable
- Plug and Play and Hardwire options available
- Suitable for use in closet applications when installed with channel and lens in accordance to NEC code
- No ultra violet (UV/IR) radiation, no mercury

APPLICATIONS

- Signage
- Lettering
- Cove and soffit lighting
- Path and contour marking
- Display lighting
- Accent and edge lighting
- Backlighting

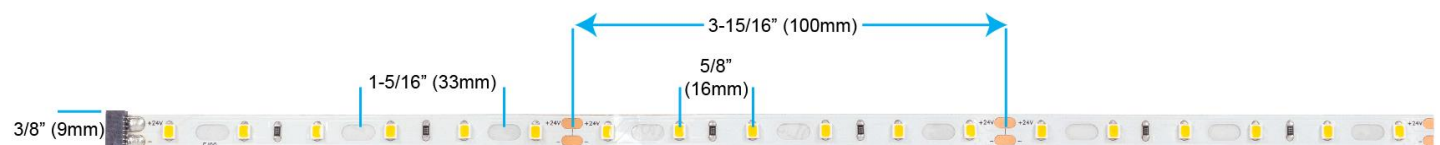

www.jescolighting.com
support@jescolighting.com
Tech Support: 855.592.0029

15 Harbor Park Drive
Port Washington, NY 11050
Main Line: 800.527.7796
Fax Line: 855.265.5768

219 South 6th Ave
City of Industry, CA 91746
Main Line: 855.654.0110
Fax Line: 626.333.2955

9/25/2020

Specifications subject to change without notice.



DL-FLEX2-UP-3D

3D BENDABLE LED FLEXIBLE LINEAR
24VDC LED FLEXIBLE TAPE

Type	
Project	
Catalog No.	

ORDERING INFORMATION

SERIES	MODEL	COLOR
DL-FLEX2	UP-3D	
		2790 – 2650-2800K / 90CRI
		3090 – 2950-3150K / 90CRI
		4090 – 3800-4150K / 90CRI

DL-FLEX2-UP is packed in 17 ft reel lengths.
Specify required amount of 1 ft lengths before the ordering number.
Example: 10 x DL-FLEX2-UP-3D-3090

ACCESSORIES

	Part Number	Description
	DL-FLEX2-X-CONN	White Universal "X" Connector Connects four DL-FLEX strips. Cut to make 2-way "L" connection or 3-way "T" connection.
	DL-FLEX-X-CONN	Red Universal "X" Connector Connects four DL-FLEX strips. Cut to make 2-way "L" connection or 3-way "T" connection.

	Part Number	Description
	DL-FLEX-CC6	6" Blank DL-FLEX tape mid-connector.
	DL-FLEX-CC12	12" Blank DL-FLEX tape mid-connector.
	DL-FLEX2-UP-3D-4	4" Section of DL-FLEX2-UP-3D tape. Available in 2700K, 3000K and 4000K.

HARDWIRE POWER CONNECTORS

	Part Number	Description
	DL-FLEX2-PC2-HW	13 5/8" Input Power Connector * 13-1/2" wire / 3/8" DL-FLEX tape. Connects hard-wire equipment to DL-FLEX.
	DL-FLEX-PC-HW	19" Input Power Connector * 13-1/2" wire / 5-1/2" DL-FLEX tape. Connects hard-wire equipment to DL-FLEX. Recommended for tight bends entering the DL-FLEX tape.

	Part Number	Description
	DL-FLEX-PT-HW	19" Output Power Connector * 13 1/2" Bare Wire / 5 3/4" DL-FLEX tape with DL-FLEX connector. Connects DL-FLEX to hard-wire equipment.

PLUG & PLAY POWER CONNECTORS

	Part Number	Description
	DL-FLEX-PC	18" Input Power Connector * 12-1/4" cable / 5-5/8" DL-FLEX tape. Connects plug and play equipment to DL-FLEX. Recommended for tight bends entering the DL-FLEX tape.
	DL-FLEX2-PC2	12 5/8" Input Power Connector * 12-1/2" cable / 3/8" DL-FLEX tape. Connects plug and play equipment to DL-FLEX.

	Part Number	Description
	DL-FLEX-PT	13" Output Power Connector * 6-1/8" cable / 5 3/4" DL-FLEX tape with FLEX-UP connector. Connects plug and play equipment to DL-FLEX.

* All dimensions are nominal

NOTE: DL-FLEX2-UP-3D can be easily connected with the DL-FLEX2-UP-HO LED strip to go around corners.



www.jescolighting.com
support@jescolighting.com
Tech Support: 855.592.0029

15 Harbor Park Drive
Port Washington, NY 11050
Main Line: 800.527.7796
Fax Line: 855.265.5768

219 South 6th Ave
City of Industry, CA 91746
Main Line: 855.654.0110
Fax Line: 626.333.2955

9/25/2020

Specifications subject to change without notice.



DL-FLEX2-UP-3D

3D BENDABLE LED FLEXIBLE LINEAR
24VDC LED FLEXIBLE TAPE

Type	
Project	
Catalog No.	

POWER SUPPLIES

24V Plug and Play Power Supplies UL Listed

Model Number	Wattage
DL-PS-WP24/24	24
DL-PS-24/24	24
DL-PS-48/24	48
DL-PS-60/24	60
DL-PS-60/24-CL2*	60
DL-PS-90/24-CL2*	90
DL-PS-100/24-CL2*	96

* Class 2

24V Hardwire Power Supplies in Junction Box UL Listed. Class 2

Model Number	Wattage
DL-PS-20/24-JBA	20
DL-PS-60/24-JBA	60
DL-PS-96/24-JBA	96

24V Hardwire Power Supplies UL Recognized. Class 2

Model Number	Wattage
DL-PS-20/24-HWA	20
DL-PS-60/24-HWA	60
DL-PS-96/24-HWA	96

24V Hardwire 0-10V Dimmable Power Supplies in Junction Box UL Listed. Class 2

Model Number	Wattage
DL-PS-30/24-JB-OD-DIM	30W
DL-PS-60/24-JB-OD-DIM	60W
DL-PS-96/24-JB-OD-DIM	96W

24V Hardwire TRIAC Dimmable Power Supplies in Junction Box UL Listed. Class 2

Model Number	Wattage
DL-PS-40/24-JB-DIM*	40
DL-PS-60/24-JB-DIM*	60
DL-PS-100/24-JB-DIM*	96

*Min. 8W load required for proper dimming

24V Hardwire TRIAC Dimmable Power Supplies UL Recognized. Class 2

Model Number	Wattage
DL-PS-40/24-HW-DIM*	40
DL-PS-60/24-HW-DIM*	60
DL-PS-100/24-HW-DIM*	96

*Min. 8W load required for proper dimming

NOTE: UL Recognized drivers must be installed in a UL Listed junction box

COMPATIBLE DIMMERS FOR DL-PS-XX/24-JB-OD-DIM POWER SUPPLIES

LUTRON:

Lutron Diva - DVTV
Lutron Diva - NFTV
Lutron Nova T - NTFTV

LEVITON:

Leviton Illumatech - IP7

WATT STOPPER:

Watt Stopper DCLV1

Lightolier Controls:

Lightolier Controls ZP600FAM120

Philips:

Philips Sunrise - SR1200ZTUNV

COMPATIBLE DIMMERS FOR DL-PS-XX/24-JB-DIM AND DL-PS-XX/24-HW-DIM POWER SUPPLIES

LUTRON:

Lutron Ariadni AYLV-600P
Lutron Caseta PD-WCL
Lutron Caseta PD-10NXD
Lutron Diva DV-600P
Lutron Diva DVLV-600P
Lutron Maestro MA-1000
Lutron Maestro MA-600
Lutron Nova N-1000
Lutron Nova N-600
Lutron Nova NTLV-600
Lutron Rotary D-600
Lutron RaidoRA2 RRD-6ND
Lutron SkyLark CTCL-153PD
Lutron SkyLark S-600
Lutron SkyLark SLV-600P
Lutron Toggler TGCL-153PH
Lutron Vareo V-600

LEVITON:

Leviton SureSlide 6633-PLW
Leviton Vizia VPM06-1LZ

LEGRANDE:

Legrand Adorne ADWR700MMTUW2



www.jescolighting.com
support@jescolighting.com
Tech Support: 855.592.0029

15 Harbor Park Drive
Port Washington, NY 11050
Main Line: 800.527.7796
Fax Line: 855.265.5768

219 South 6th Ave
City of Industry, CA 91746
Main Line: 855.654.0110
Fax Line: 626.333.2955

9/25/2020

Specifications subject to change without notice.



DL-FLEX2-UP-3D

3D BENDABLE LED FLEXIBLE LINEAR
24VDC LED FLEXIBLE TAPE

Type	
Project	
Catalog No.	

LUTRON™ POWER SUPPLIES

Lutron 24V Dimmable PowerSupplies UL Listed (with Junction Box)			
Model Number		Dim Range	Wattage
DL-PS-L3DAE	Hi-lume 1% EcoSystem 24V LED Driver	100% – 1%	40
DL-PS-L3DA3W	Hi-lume 1% 3-wire 24V LED Driver	100% – 1%	40
DL-PS-LTEA2W	Hi-lume 1% 2-wire 24V LED driver (120 V forward phase only)	100% – 1%	40
DL-PS-L3D0E	Hi-lume Premier 0.1% EcoSystem 24V constant voltage LED driver with Soft-on, Fade-to-Black dimming technology	100% – 0.1%	96
DL-PS-L3D03W	Hi-lume Premier .1% 3-wire 24V constant voltage LED driver	100% – 0.1%	96

DIMMING OPTIONS

DS-DV-TV-WH	Wall-Plate Dimm
LC-DIM5A	0-10V Plug & Play Dimmer
LC-DIM5A-HW	0-10V Hardwire Dimmer
LC-DIM100-RF	Plug & Play Remote Step Dimmer
LC-DIM100-RF-HW	Hardwire Remote Step Dimmer
LC-200-RPT	Power Repeater
LC-DIM200-RF-HW	Simple Hand-held Radio Frequency Dimmer Controller
LC-RF-400H-DIM	Hand-held Radio Frequency Dimmer Controller
LC-RF-400W-DIM	Wall Mounted Radio Frequency Dimmer Controller
LC-RF-402W-DIM	Wall Mounted Dual Radio Frequency Dimmer Controller
LC-RF-400-RCV	Radio Frequency Receiver

LED DRIVER + IN-WALL DIMMER SWITCH



DL-PS-100/24-DIM-WS

LED Driver + In-Wall Dimmer Switch

Dims: 4.1" L x 2.1" W x 1.4" H
Max Output: 100W
Rated Load Current: 4.2A

- LED Driver + In-Wall Dimmer Switch in one unit
- Simplifies LED installation by eliminating compatibility issues between driver and dimmer
- Fits in a standard recessed electrical box
- 100% - 1% smooth dimming. No minimum load
- Single Pole preset dimmer with on/off push switch
- Adjustable voltage output dial to address voltage drop
- Includes voltage barrier partition to install high and low voltage circuit in same switch box
- No derating required when ganging units
- Power failure memory: If power is interrupted, the dimmer will return to setting prior to interruption
- Three faceplates included: Glossy White, Glossy Light Almond, and Glossy Dark Brown (trim plates not included)



DL-FLEX2-UP-3D

3D BENDABLE LED FLEXIBLE LINEAR
24VDC LED FLEXIBLE TAPE

Type	
Project	
Catalog No.	

WIRING DIAGRAMS – For reference purposes only. Not to scale.

PLUG & PLAY

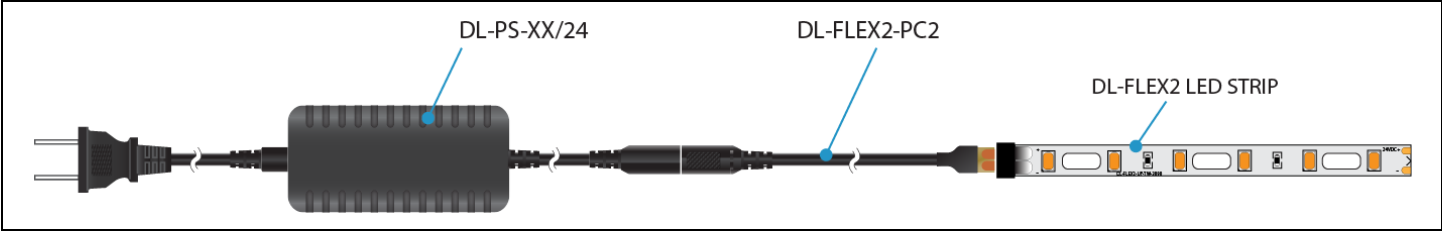

HARDWIRE

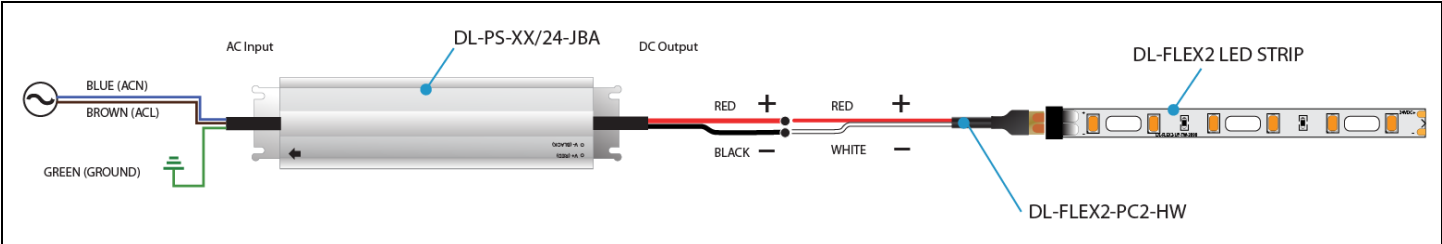

HARDWIRE • TRIAC Dimming

For dimming see DL-PS-XX/24-JB-DIM or DL-PS-XX/24/HW-DIM series specification sheet (minimum 8W load is required)

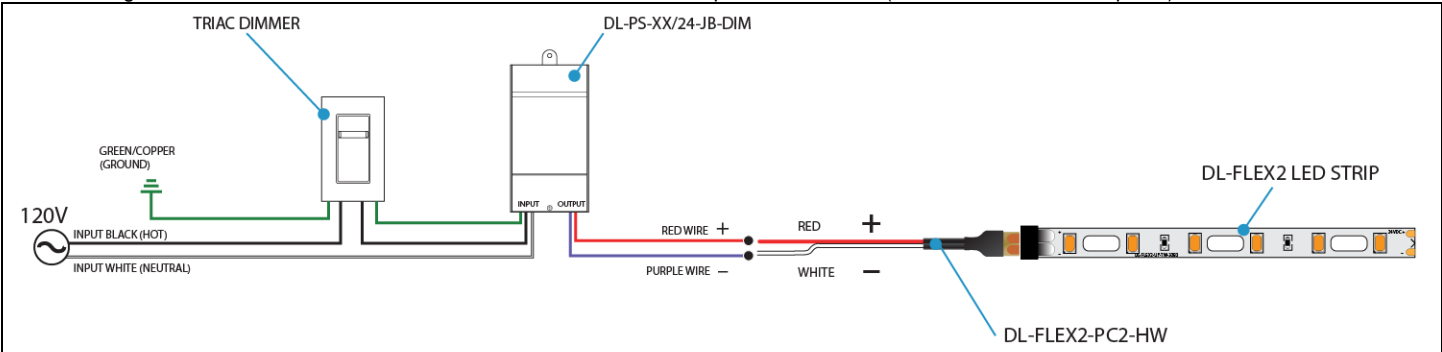

HARDWIRE • 0-10V Dimming

For dimming see DL-PS-XX/24-JB-OD-DIM series specification sheet

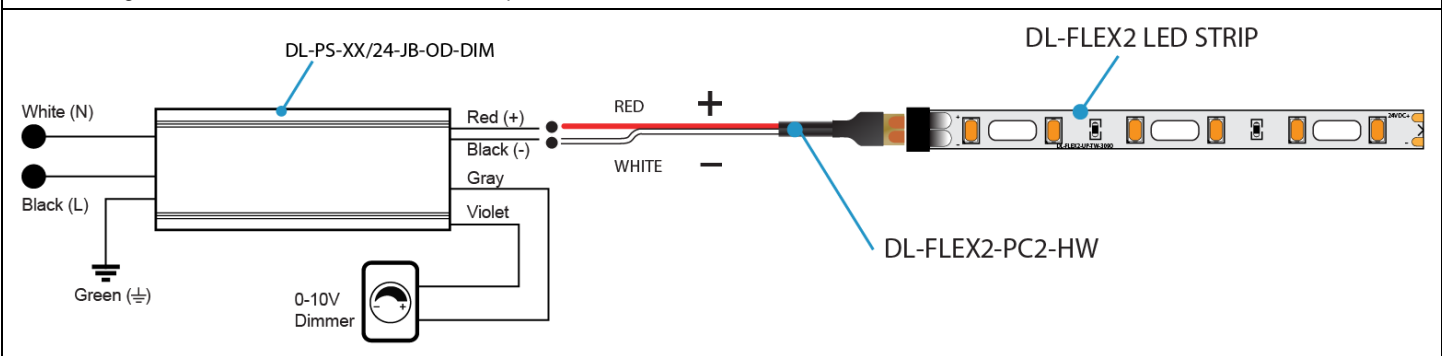



DL-FLEX2-UP-3D

3D BENDABLE LED FLEXIBLE LINEAR
24VDC LED FLEXIBLE TAPE

Type	
Project	
Catalog No.	

HARD-WIRE • PWM 0-10V Dimming (Using our LC-DIM-5A-HW Dimming Module)

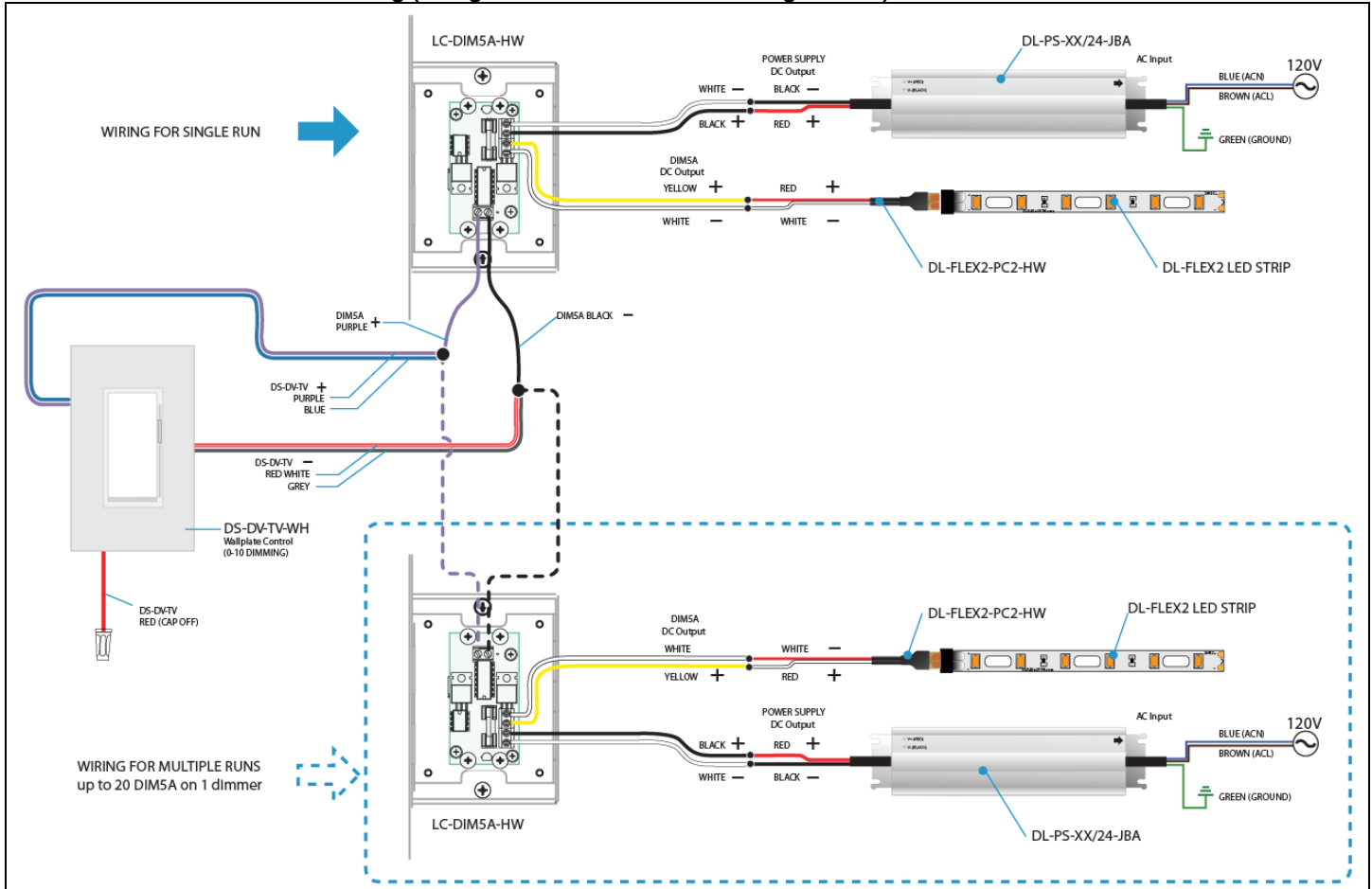

Plug and Play • PWM 0-10V Dimming (Using our LC-DIM-5A Dimming Module)

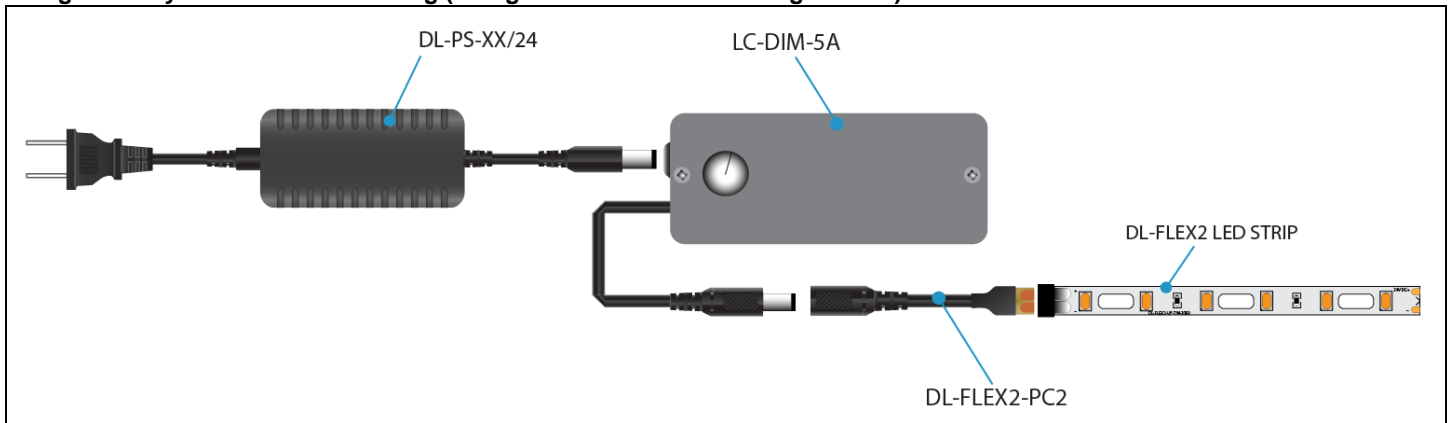



DL-FLEX2-UP-3D

3D BENDABLE LED FLEXIBLE LINEAR
24VDC LED FLEXIBLE TAPE

Type	
Project	
Catalog No.	

CHANNEL FEATURE MATRIX

	ROUGH-IN				MEDIUM DEPTH PROFILE				SMALL DEPTH PROFILE					BASIC		
	CH-RI-11	CH-RI-12	CH-RI-13	CH-RI-15	CH-ME-21	CH-ME-22	CH-ME-24	CH-ME-25	CH-SM-31	CH-SM-32	CH-SM-33	CH-SM-34	CH-SM-35	DL-FLEX-CH6	DL-FLEX-CH6-B	DL-FLEX-OD-CH6
DL-FLEX2-UP-3D	●	●	●	●	●	●	●	●	●	●	●	●	●	●	●	●
Surface Mounting			C	C/E	D		D	D	D		D		D	D	D	D
45° Mounting							●						●			
Recessed – For Miter Grooves					F	G			F	G	F	G				
Rough-in – For Walls & Ceilings	A/B	A	A	A												
Adjustable Mounting									●						●	
Outdoor Mounting																●
Flangeless			●	●	●		●	●	●		●	●	●	●	●	●
Flanged	●	●				●				●		●				
Lens Included									●	●	●	●	●			
Lensless														●	●	●
Lens – UV and Fire Rated up to 240F option	●	●	●		●	●	●	●								
Small Profile Depth – Diffused Light									●	●	●	●	●	●	●	●
Medium Profile Depth – More Diffused Light					●	●	●	●								
Large Profile Depth – Best Diffused Light	●	●	●	●												
Aluminum – Anodized	●	●	●	●	●	●	●	●	●	●	●	●	●	●	●	●
6 Ft. Length									●	●	●	●	●	●	●	●
6-1/2 Ft. Length (2 meters)	●	●	●	●	●	●	●	●								

SUGGESTED MOUNTING TECHNIQUES

A Drywall Recessed Rough-In Mounting with Channel Housing

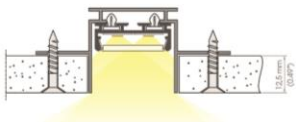

B Drywall Recessed Rough-In Mounting with Spring Clip



C Surface Mounting onto Drywall or Drop Ceilings

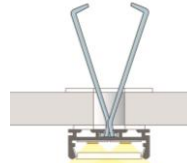

D Surface Mounting with Bracket

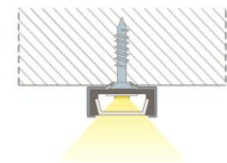

E Surface mounting by Sliding onto Flat Head Screws

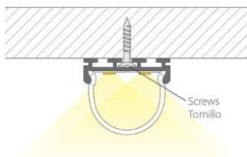

F Recessed Mounting into Mitered Groove with Bracket

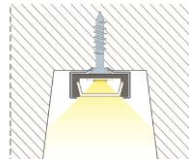

G Recessed Mounting into a Mitered Groove using a flanged Channel

